

FRAMING

Rockfon[®] **Lamella**[™]

How to fit around windows, doors, TV-screens etc.

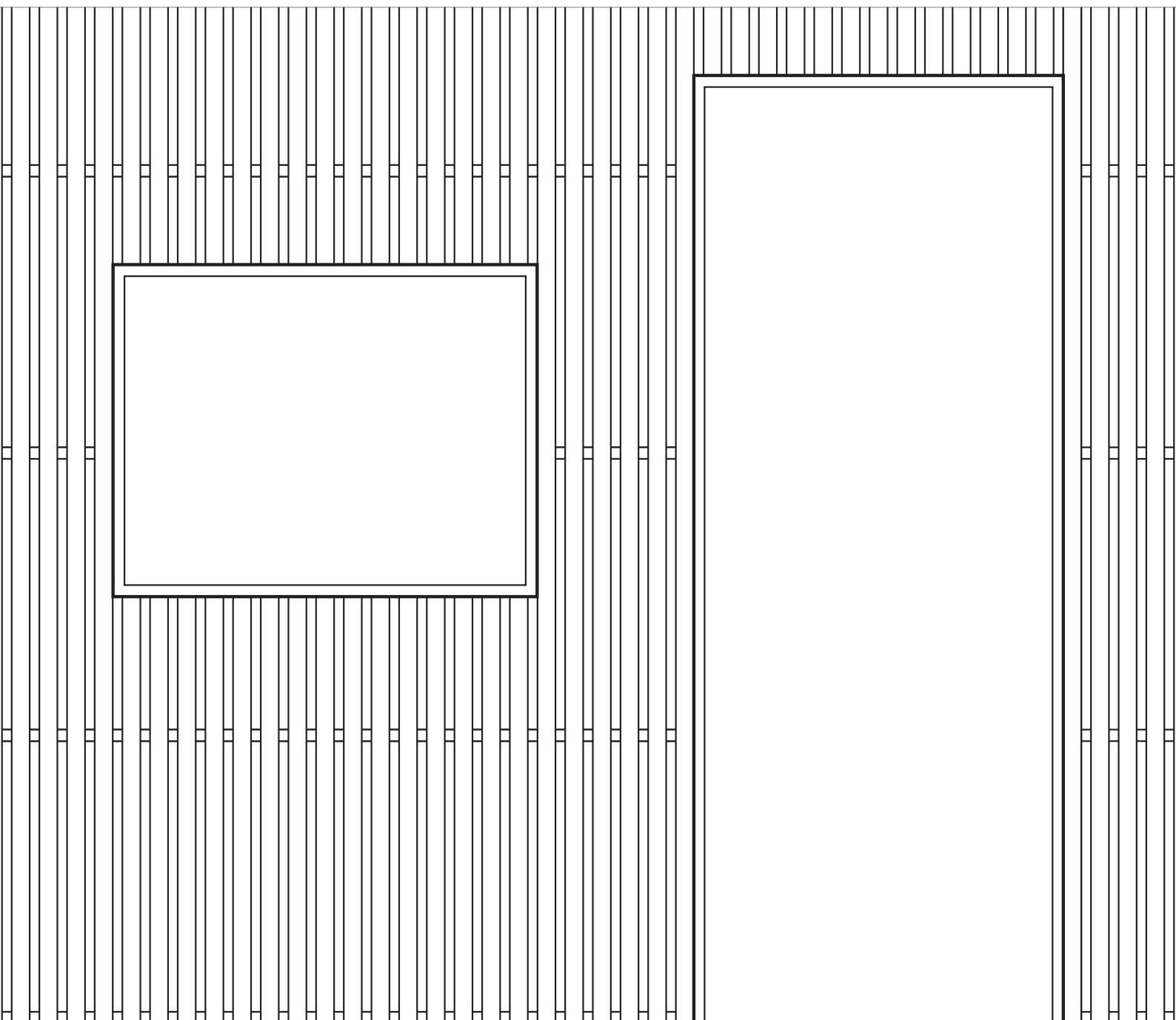

Description

A: Framing around TV screen

A (TV) screen in a meeting room will typically be installed approx. 1200mm from the floor, depending on the size. It's recommended to have a gap from the Top/Bottom profiles and the End profiles to the screen. It's recommended to paint this gap against background black.

- Top/Bottom profile
- Middle profile
- End profile

Other configurations are possible. Please contact Rockfon for more info.

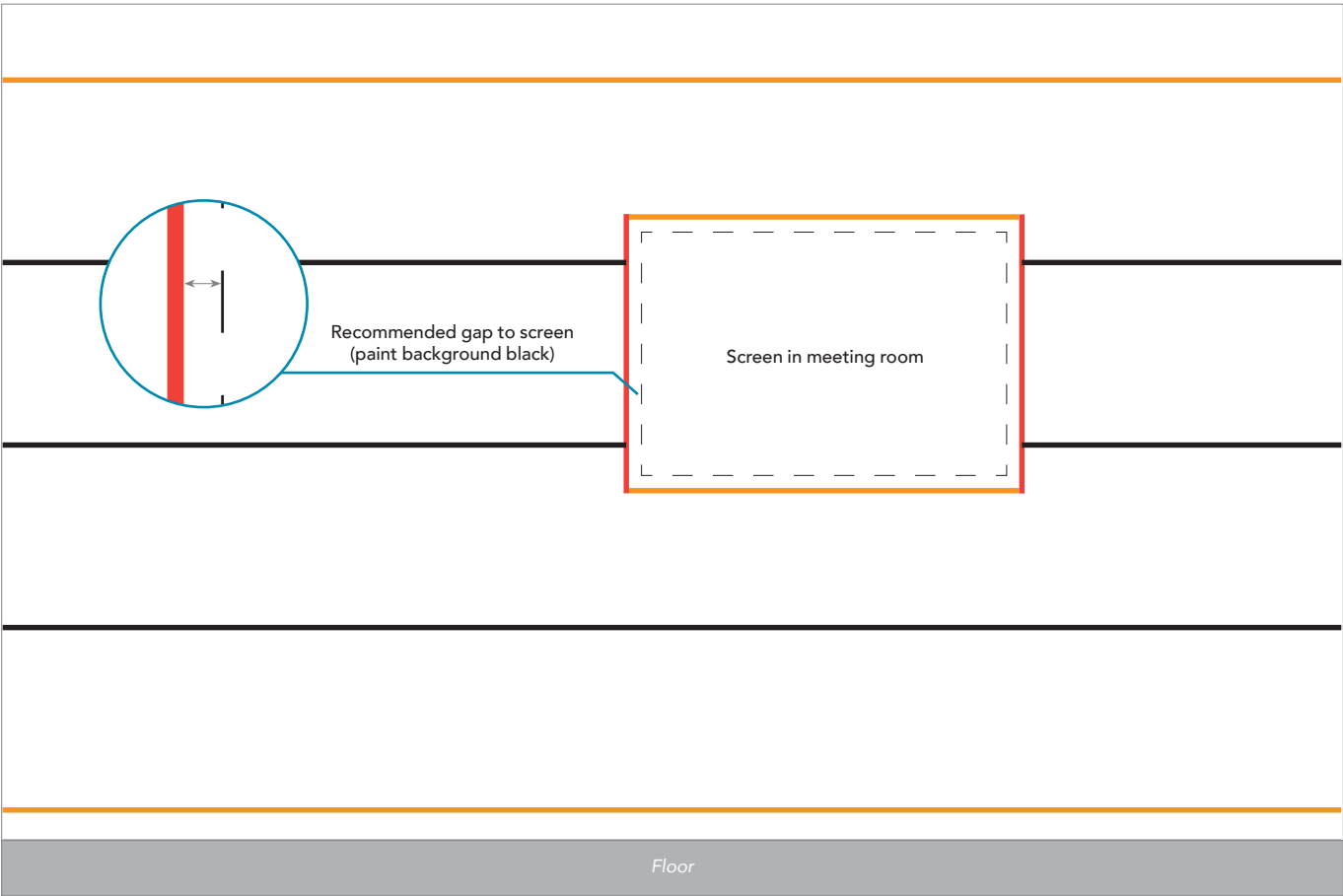

B: Framing around window/screen

Windows are very different in size and in placement. Below an example of a random sized window, fully integrated in Rockfon Lamella.

- Top/Bottom profile
- Middle profile
- End profile

Other configurations are possible. Please contact Rockfon for more info.

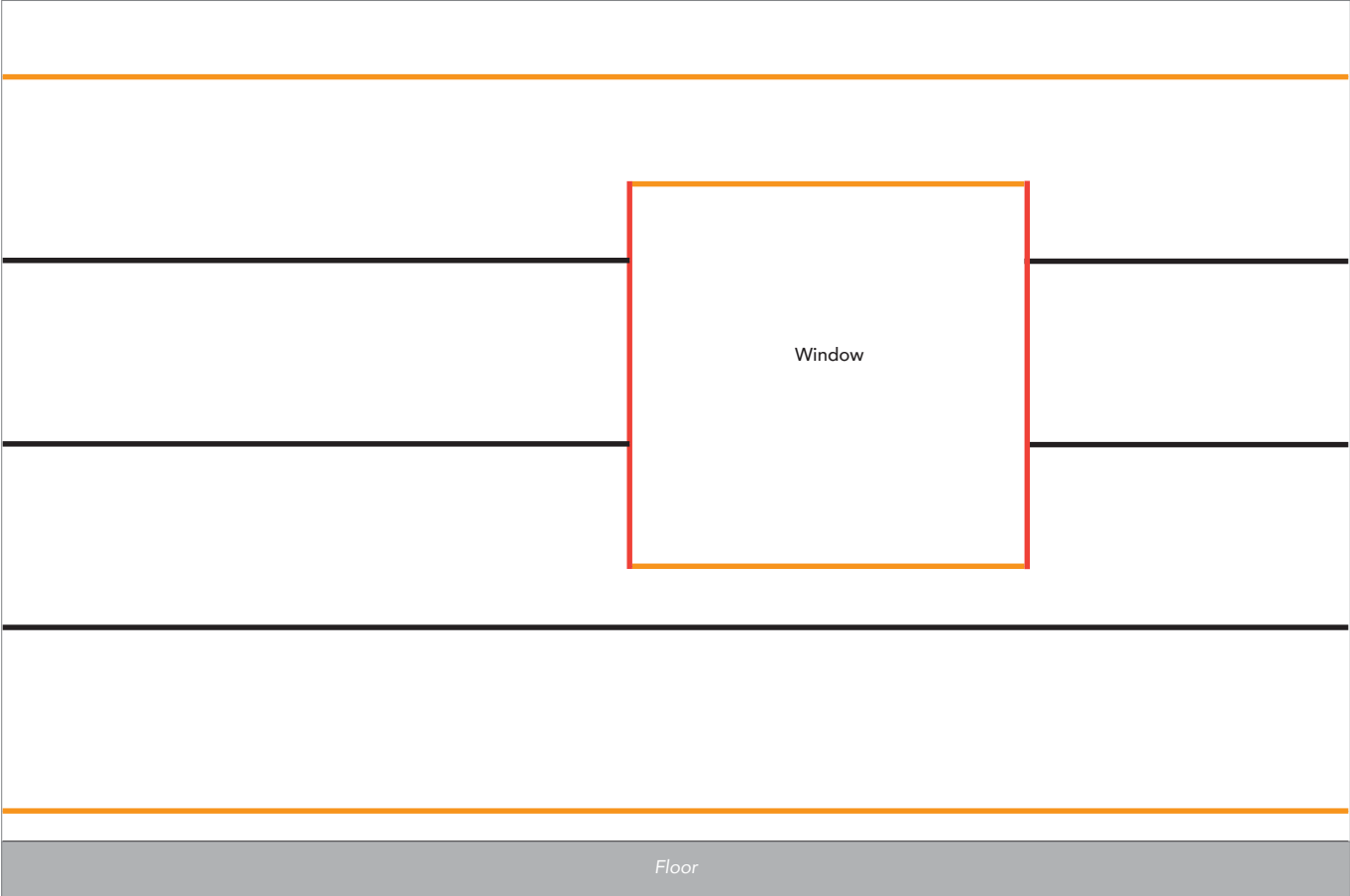

C: Framing around low window/screen

If a frame is wanted in a space where the End profiles that make the frame to the sides, are not supported by at least two Middle profiles, it is needed to mount additional Middle profiles.

- Top/Bottom profile
- Middle profile
- End profile

TIP! Make sure to align the alignment holes vertically with the other profiles. You need to mark the profiles before cutting them.

Other configurations are possible. Please contact Rockfon for more info.

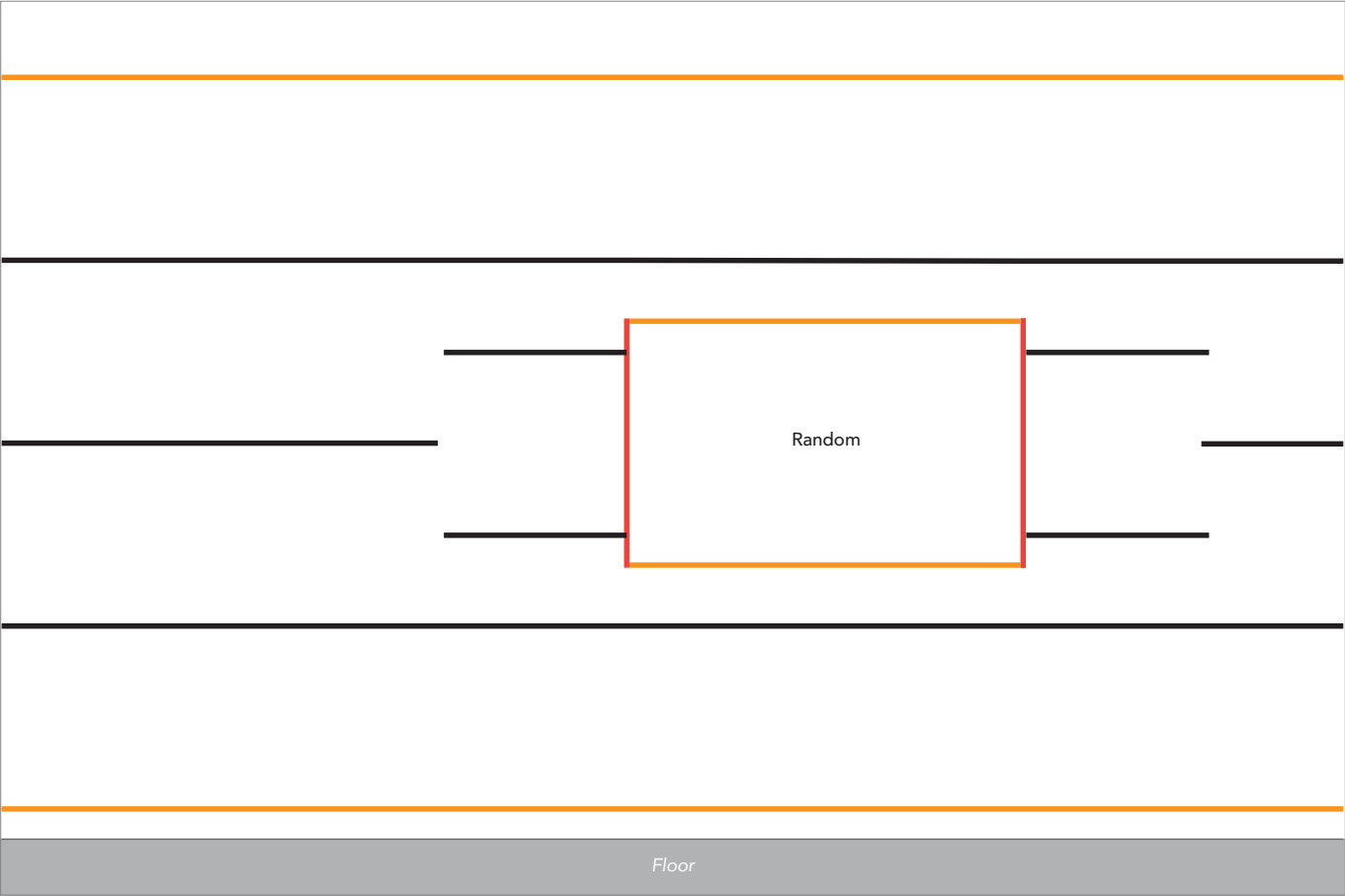

D: Framing around door

The height of a door is typically between 2040 and 2110 mm, depending on country/market. Below an example of a common situation, where a door is fully integrated in Rockfon Lamella.

- Top/Bottom profile
- Middle profile
- End profile



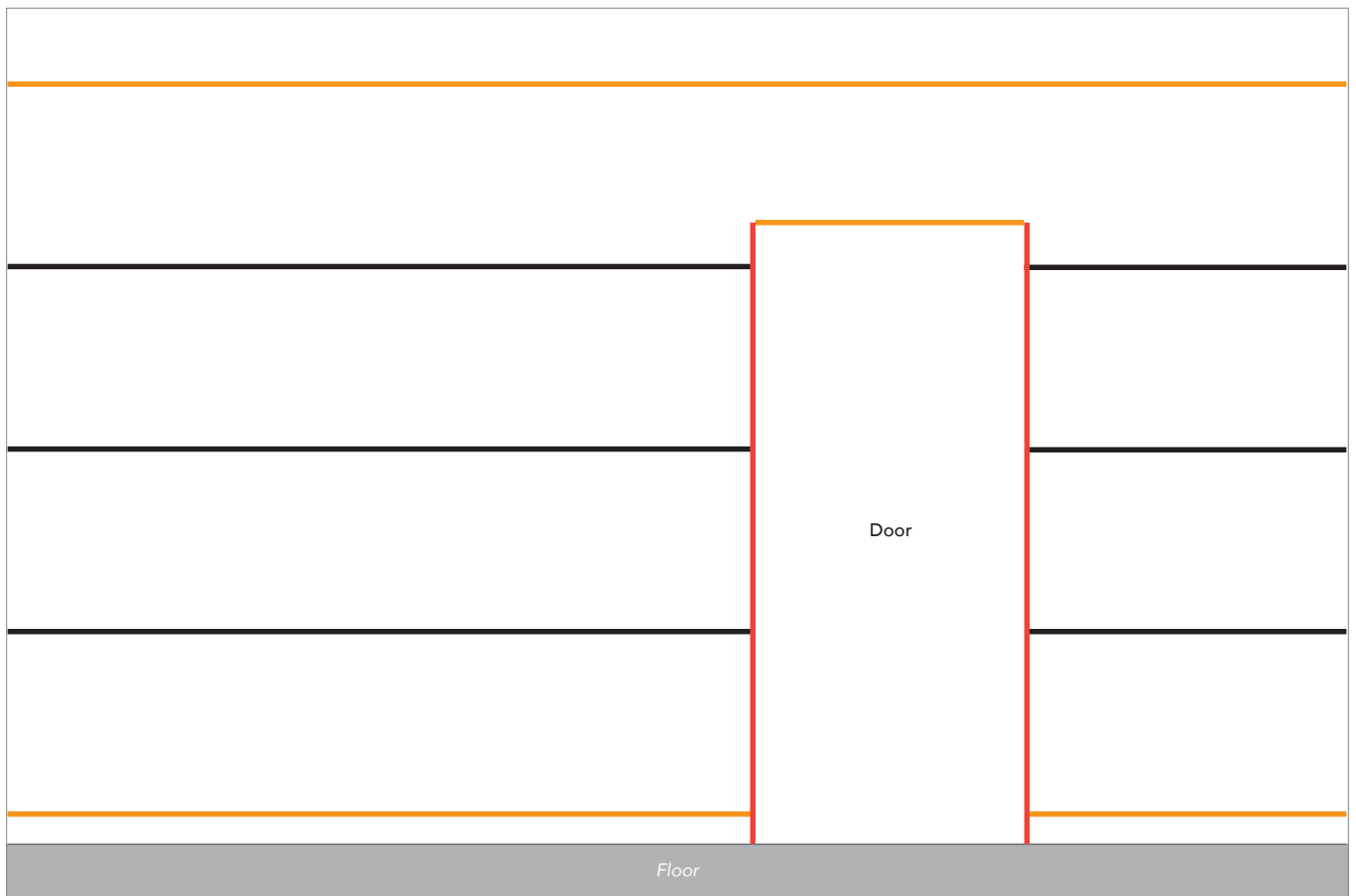



Other configurations are possible. Please contact Rockfon for more info.



Installation

A: Framing around TV screen

Tool List

Tools	Drill machine	Utility knife	Saw	Ruler	Laser	Level
						

- 1 Mark the corners of your planned installation.

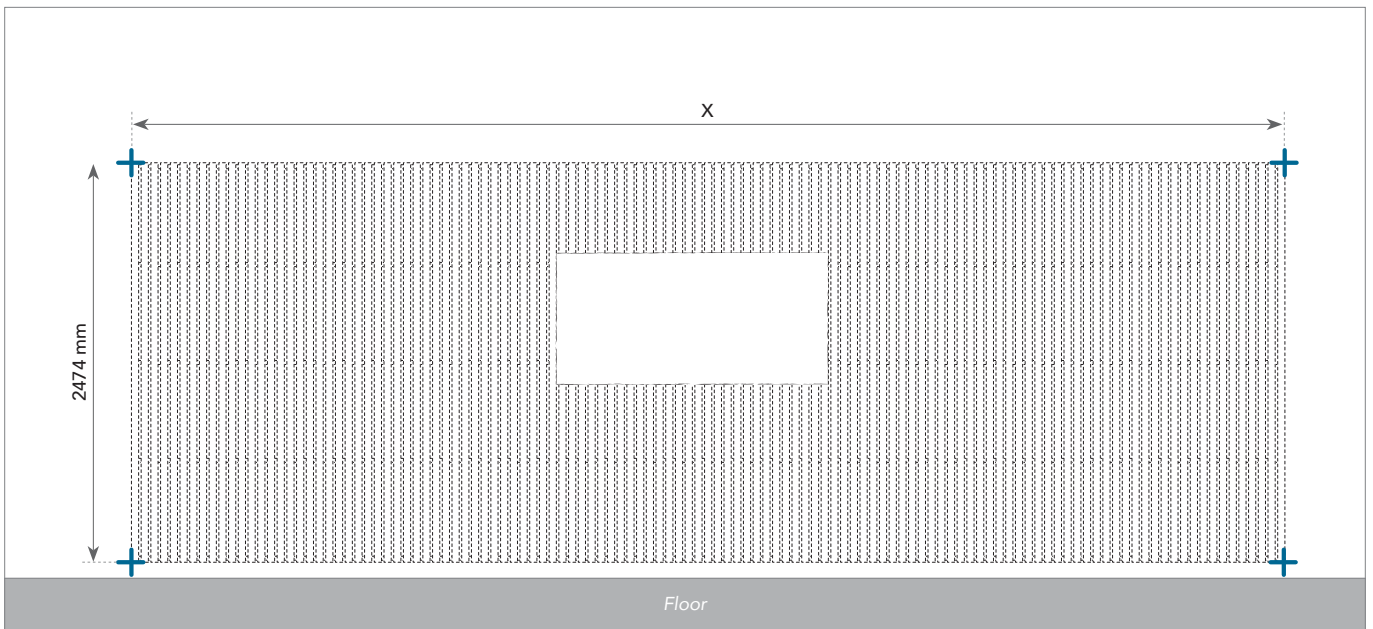

- 2** If applicable, mark the location of the frame on the wall.

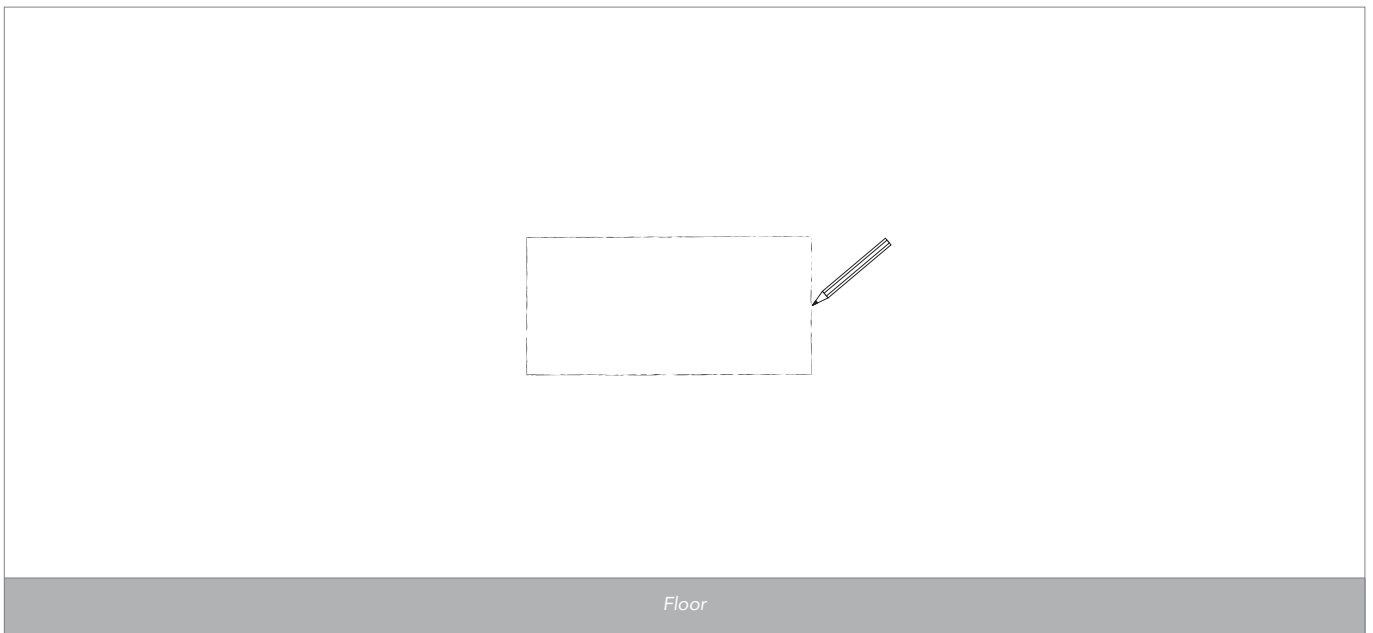

- 3** Mount the profiles.

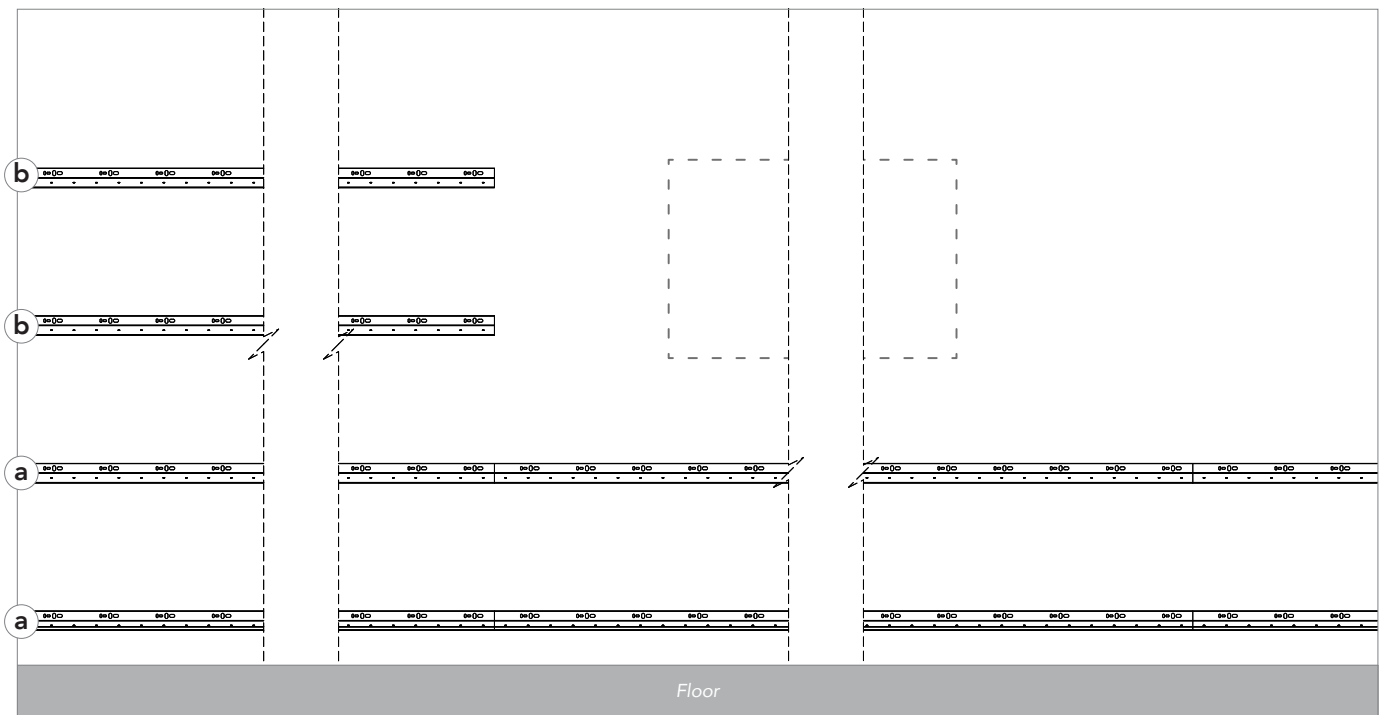

- a) Mount the Top/Bottom and Middle profiles under the desired frame.
 b) Mount the remaining Middle profiles and stop before fitted profiles are needed (at least 9 mm before your marking).

4 Measure and cut fitted profiles.

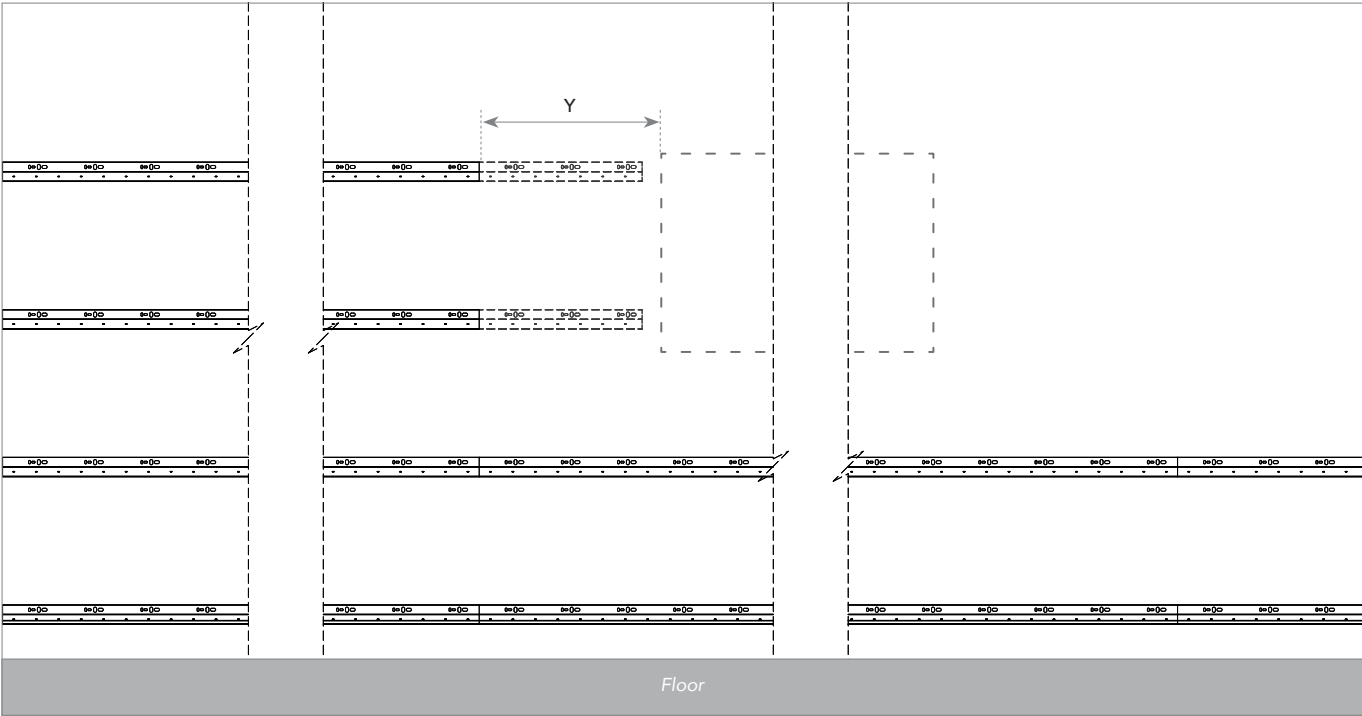

Measure Y.
Cut Middle profiles in length Y - 11mm. Remember to cut the profiles at the correct end (cut away the right end, when working left to right and vice versa).



RECOMMENDATIONS 

Keep the cut-off end for later.

5 Mount the fitted profiles.

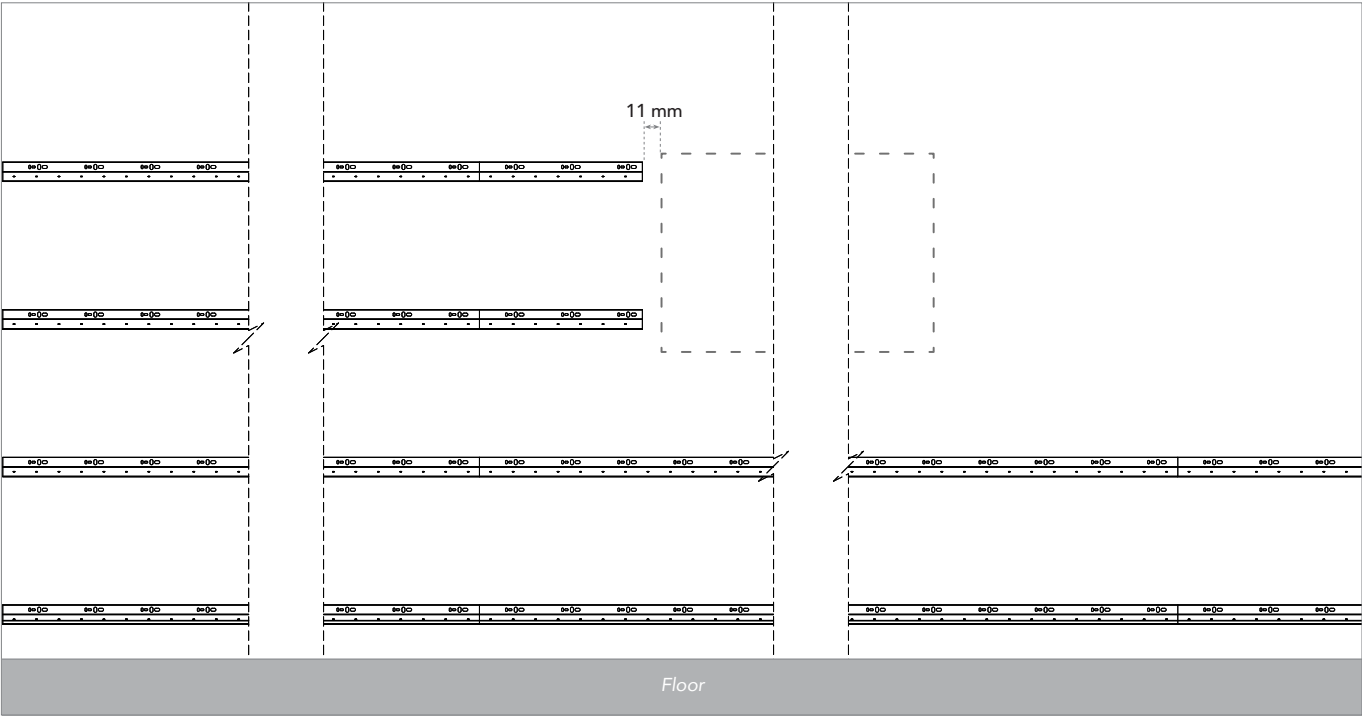

6 Mount the fitted profiles.

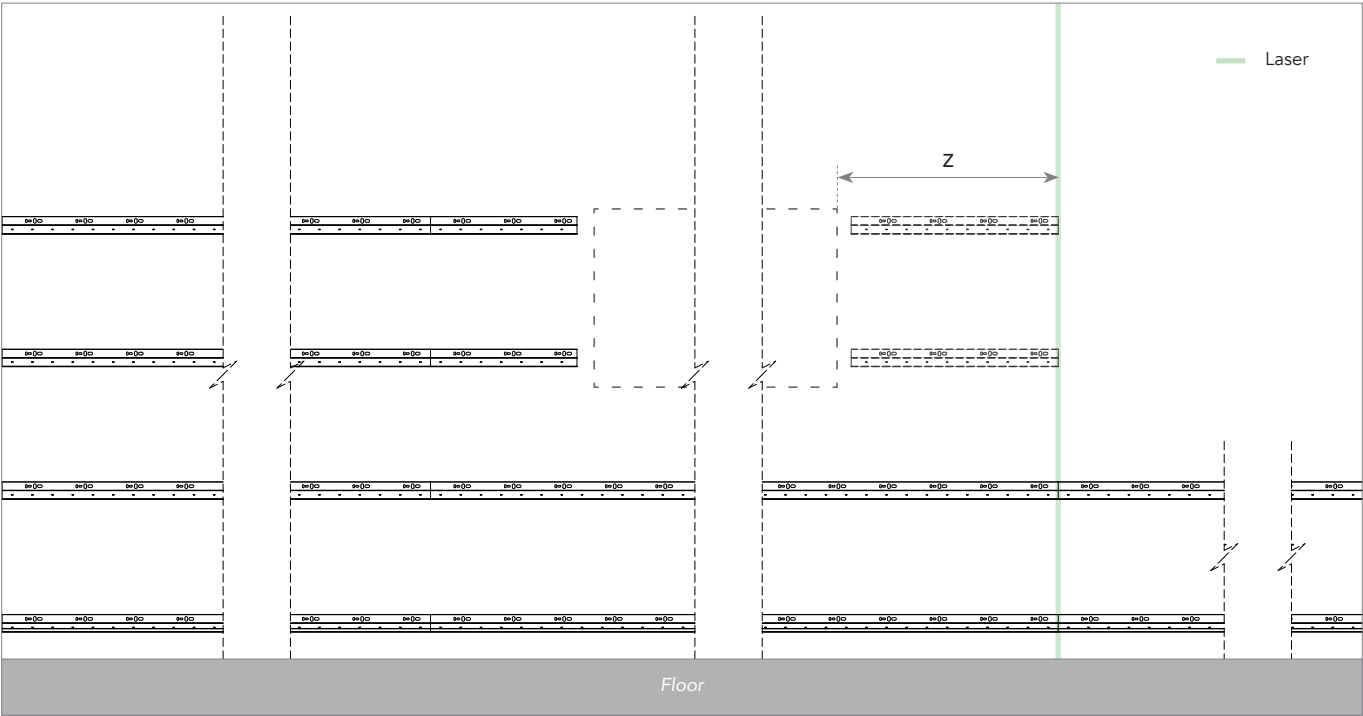

On the opposite side of the frame:
Align the laser vertically on the profile joint (or end) on the below horizontal profiles.

Measure Z.
Cut the Middle profiles in length Z - 11mm (use remaining pieces from step 4 if possible). Remember to cut the profiles at the correct end (cut away the left end, when working left to right and vice versa).

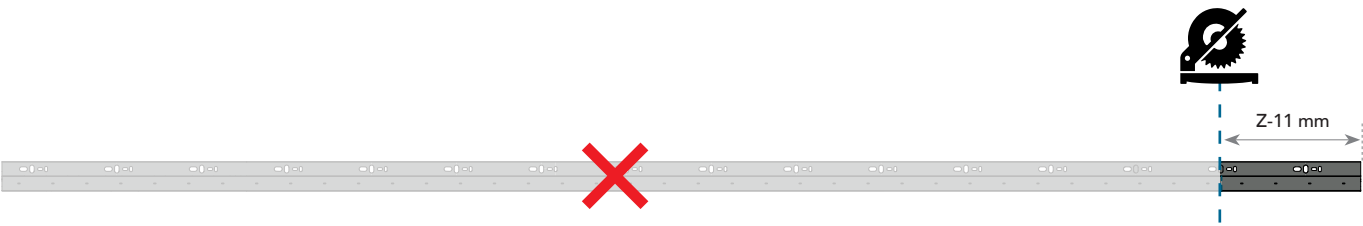

7 Mount the fitted profiles.

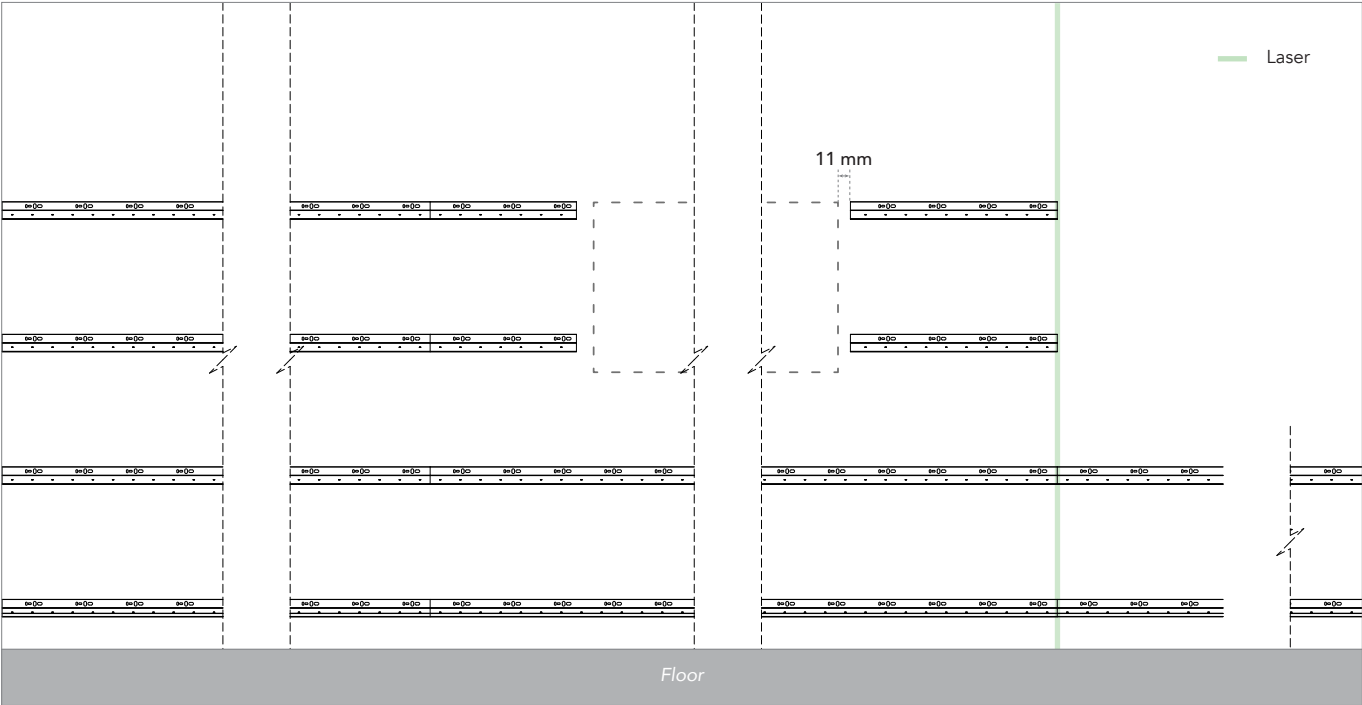

8 Mount the fitted profiles.

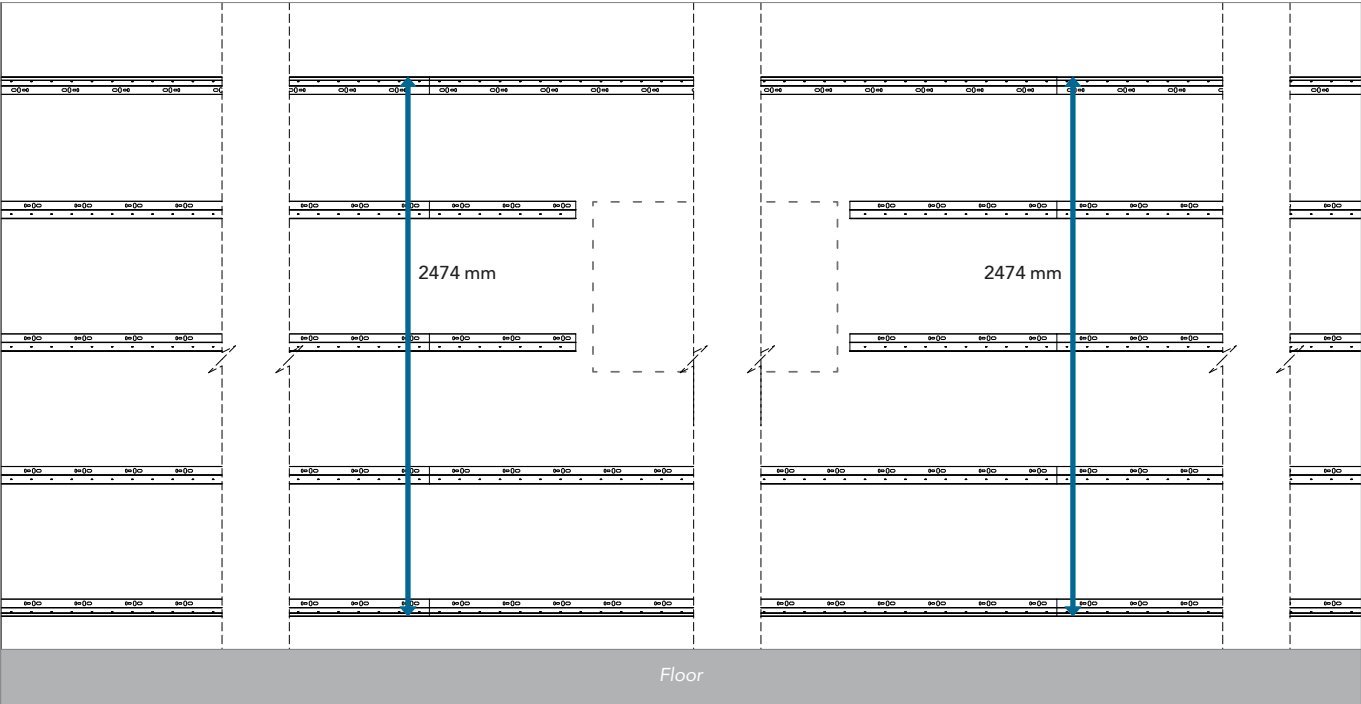

RECOMMENDATIONS 

Control measurements marked by the blue arrows are highly recommended.

9 Measure and cut the two End profiles.

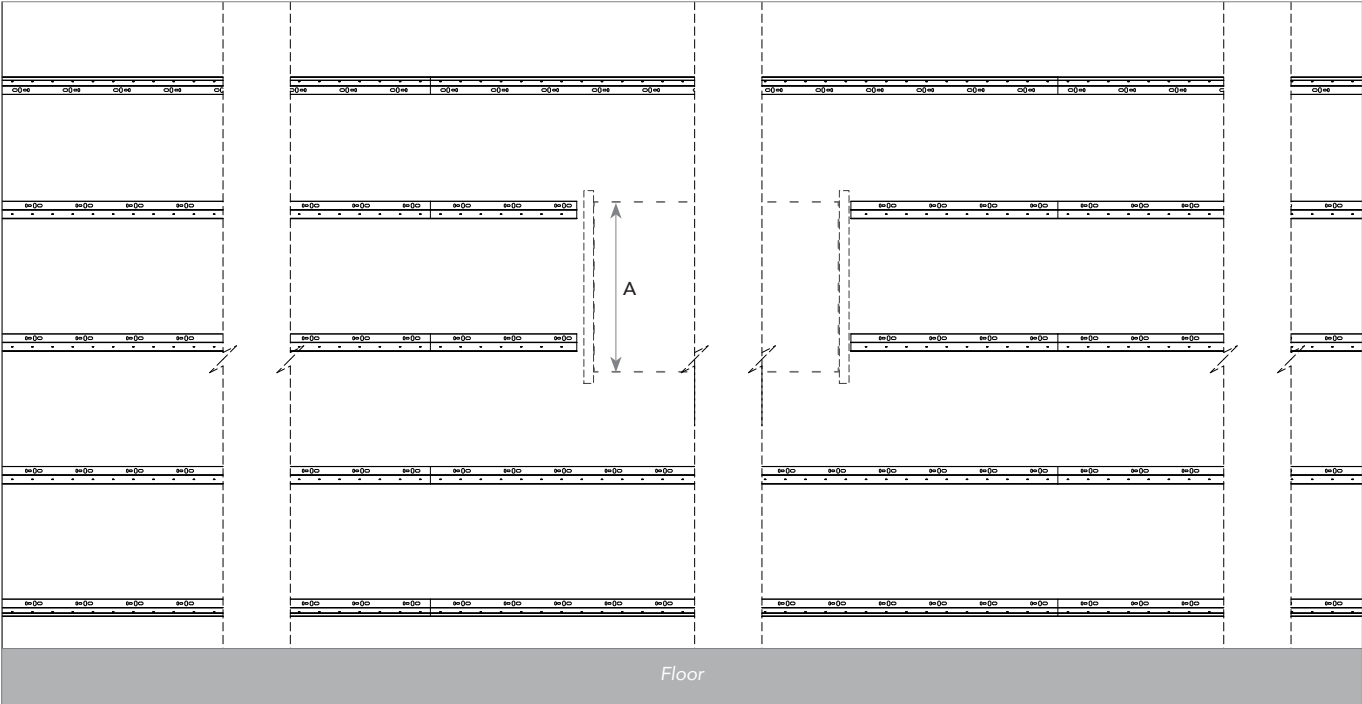

Measure A.
Cut End Profiles – Left/Right to A + 20mm.

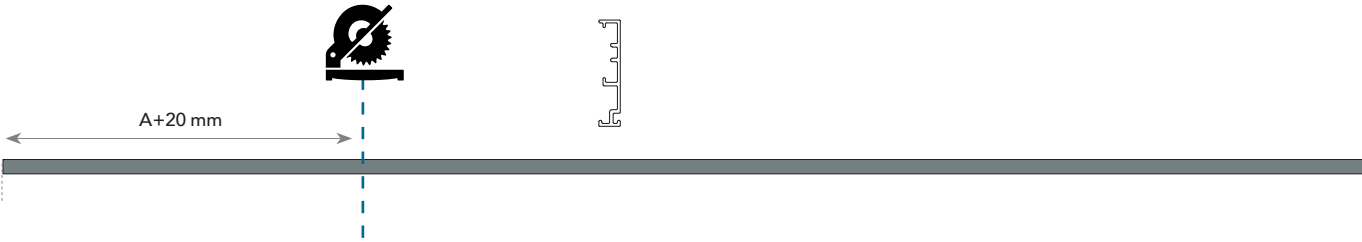

10 Mount the fitted profiles.

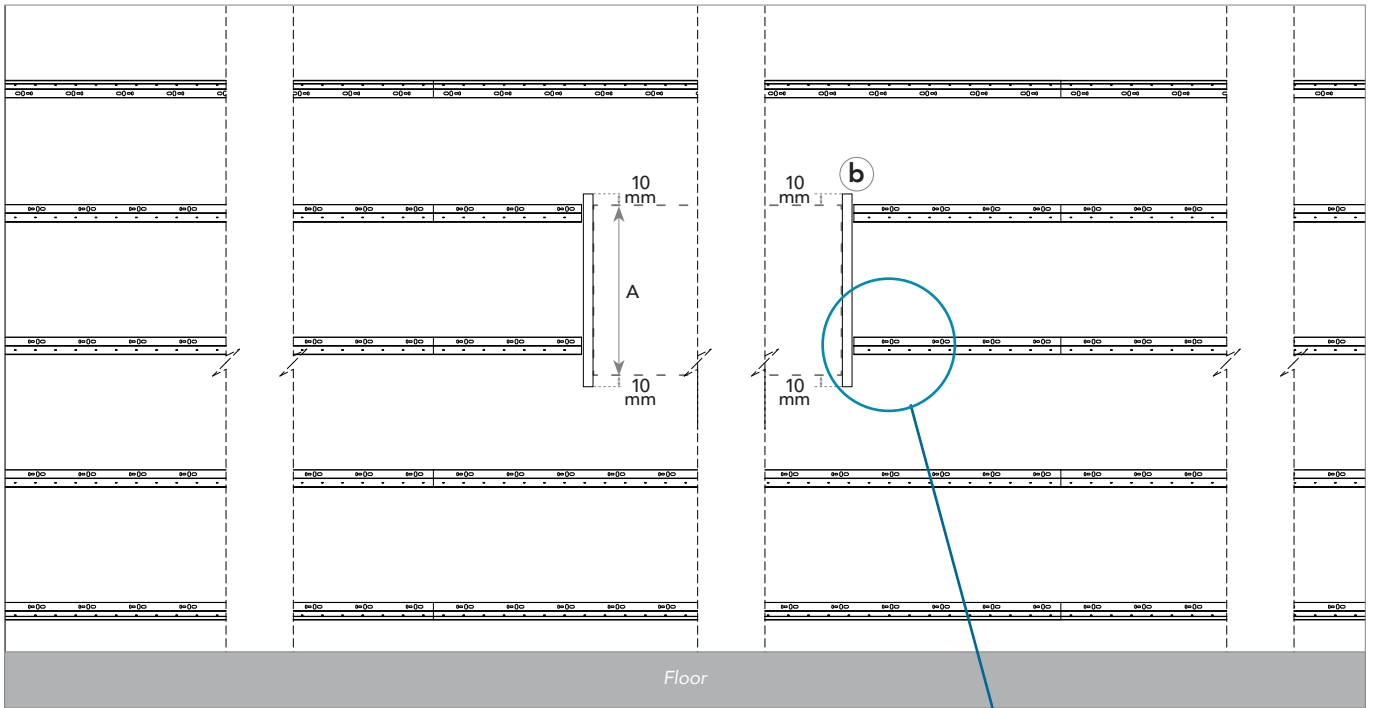

Mount the two End Profiles using the End Connector Bracket. Offset the ends of the Vertical End Profiles with 10 mm past the frame marking at each end.

- a) First fasten the set screw in the Middle Profile.
- b) Align and level the End profile with your frame marking.
- c) Fix the second set screw into the End Profile.



11 Measure and cut two Top/Bottom profiles.

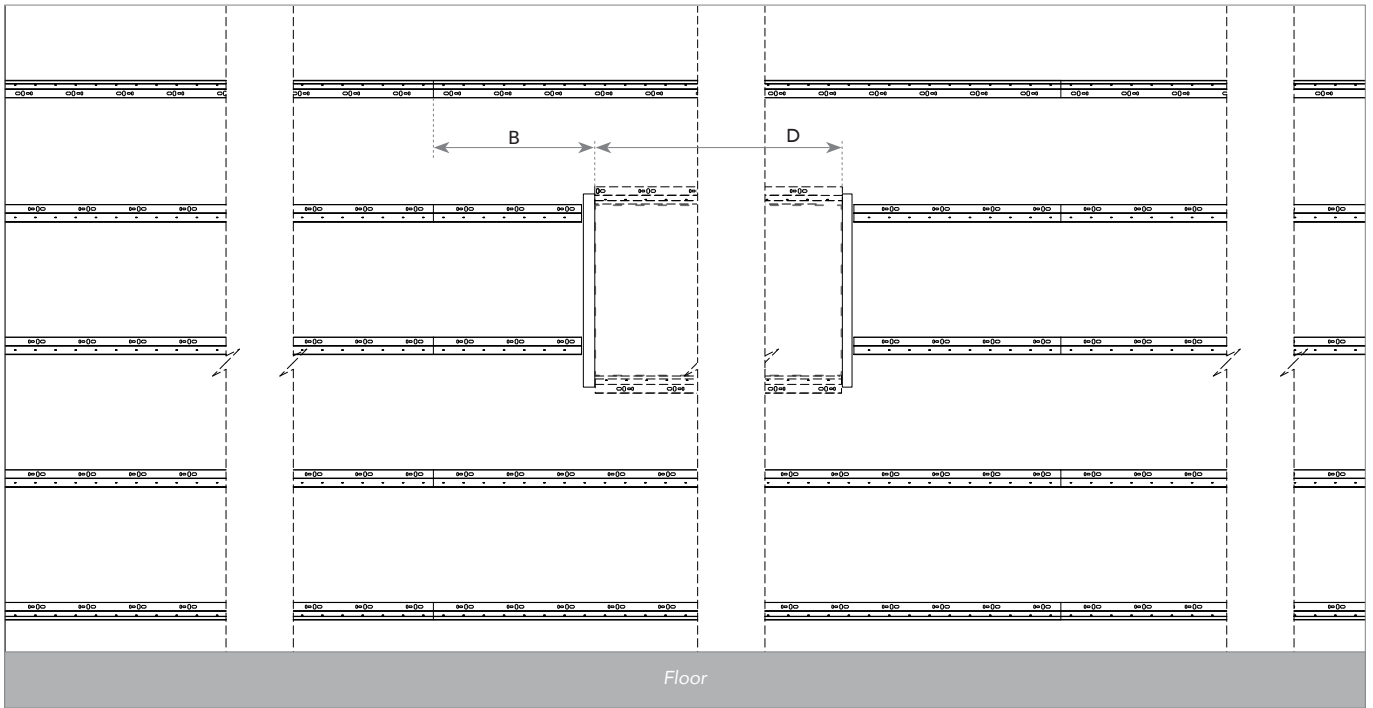

Measure the distance from the vertical frame to the nearest profile joint/end (B). Take two Top/Bottom (!) profiles and flip one of them (a) before marking for cutting. Cut the two Top/Bottom profiles in each end, corresponding to the measure B.

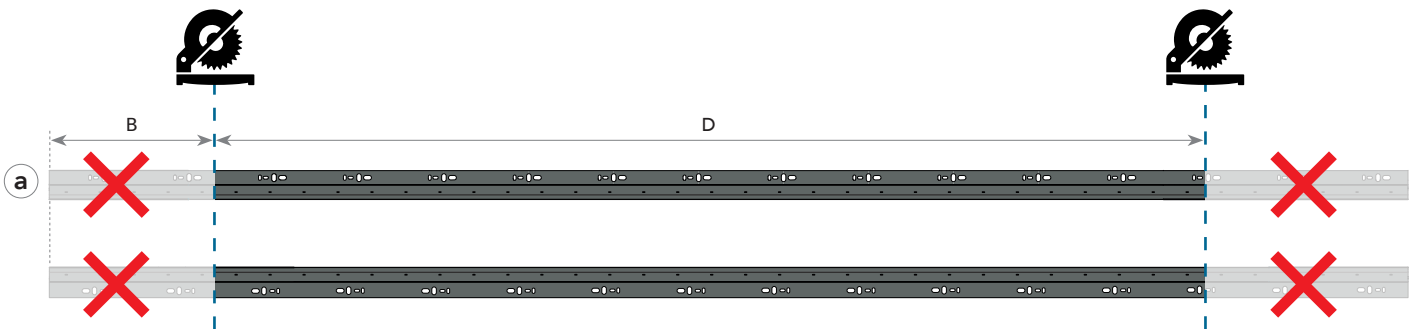

ATTENTION !

Make sure to flip one Top/Bottom profile before marking and cutting (a).

12 Mount the two Top/Bottom profiles.

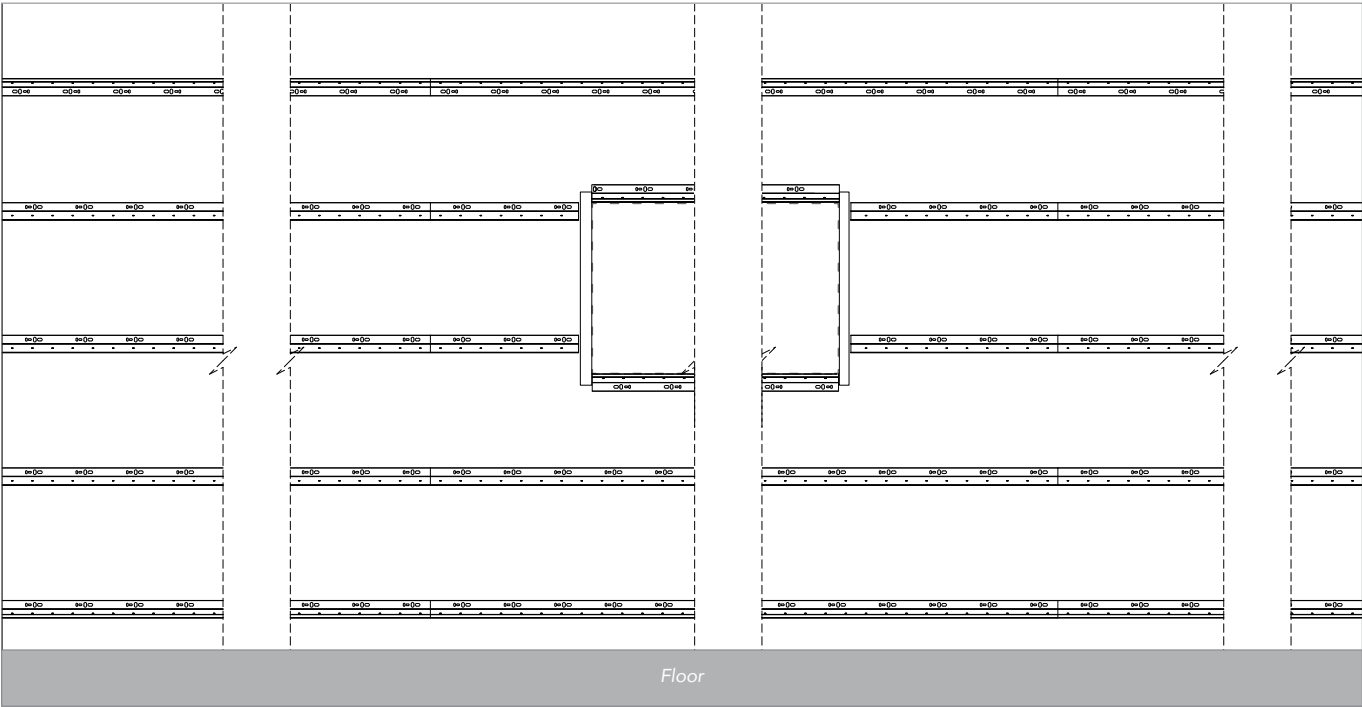

Mount the Top/Bottom profiles with the screw flanges pointing away from the frame. Align the profiles with your marking.

13 Insert bottom spacers.

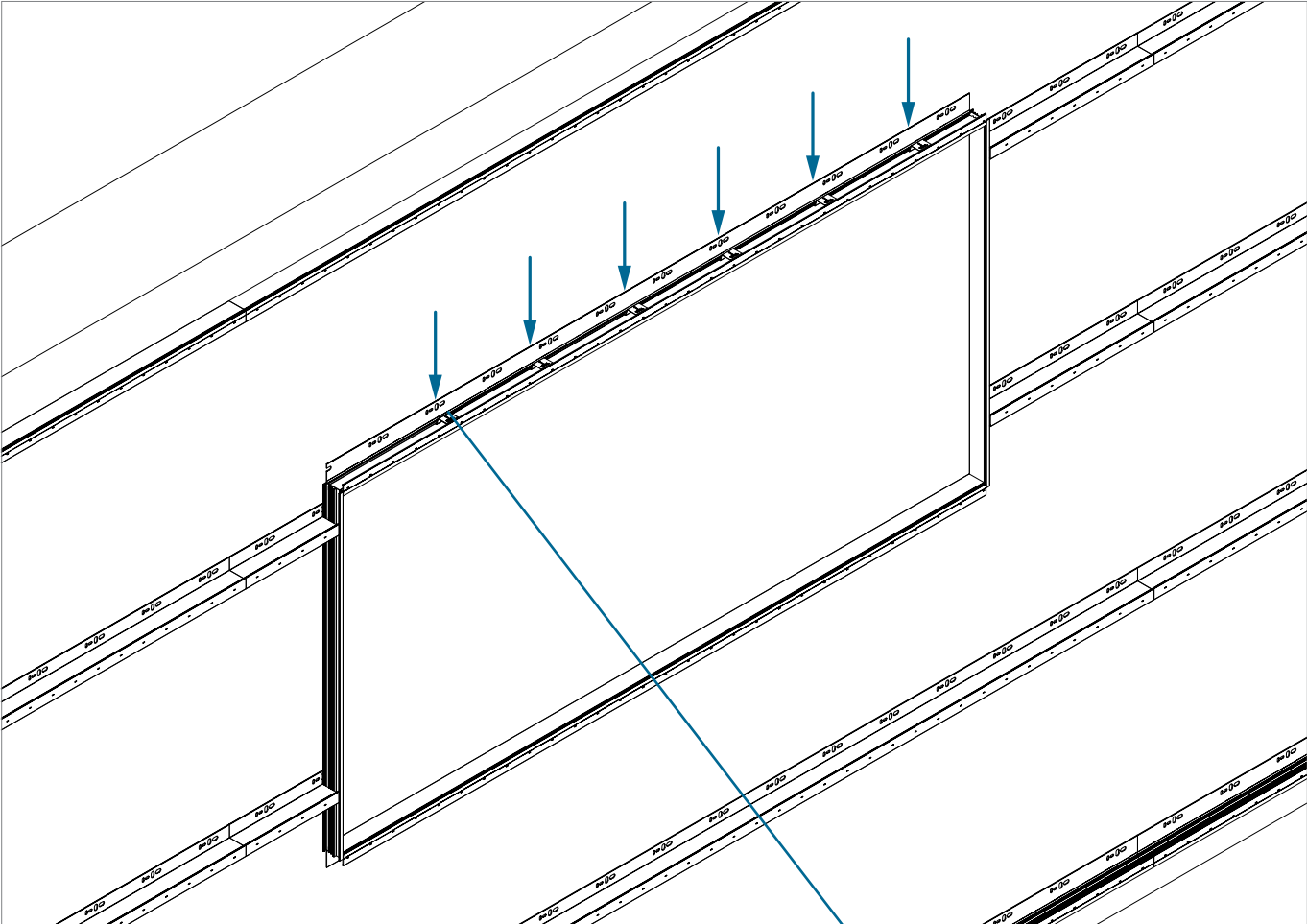

Insert two bottom spacers per panel.

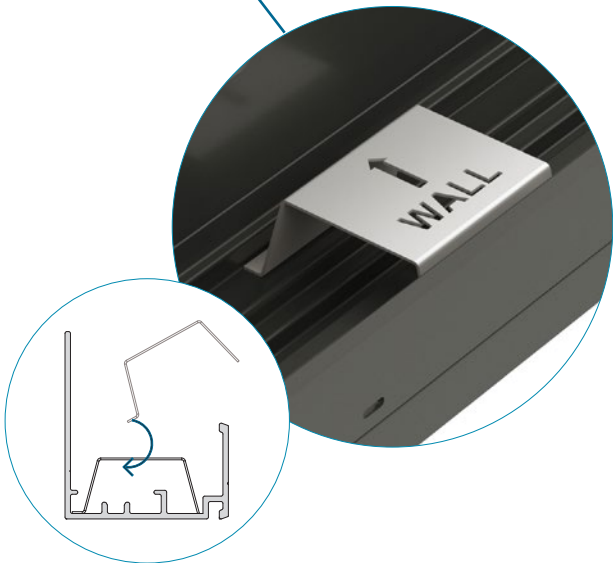

14 Cut and mount panels.

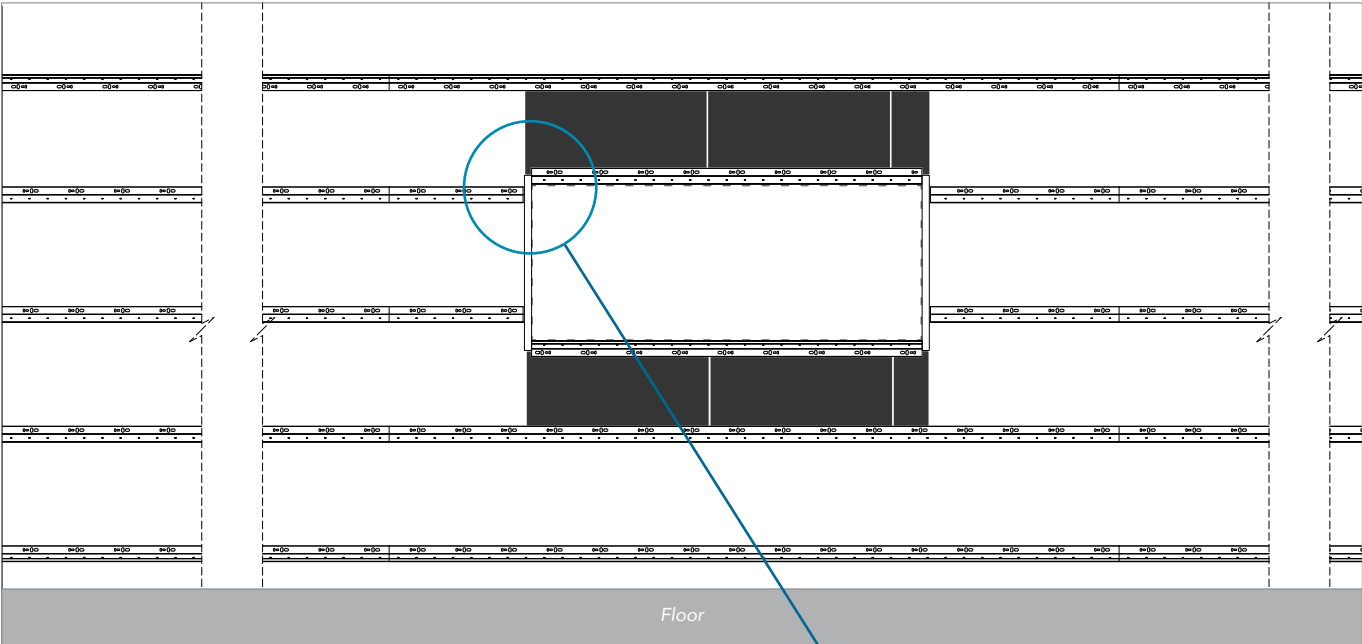

Cut and mount the panels above and below the frame. Make the ends of the panel finish approximately 15mm on the outside of the frame.

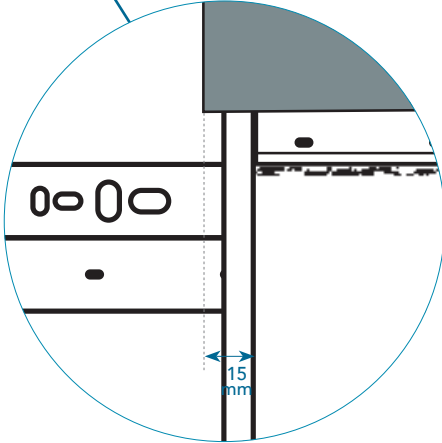

15 Mount the rest of the panels.

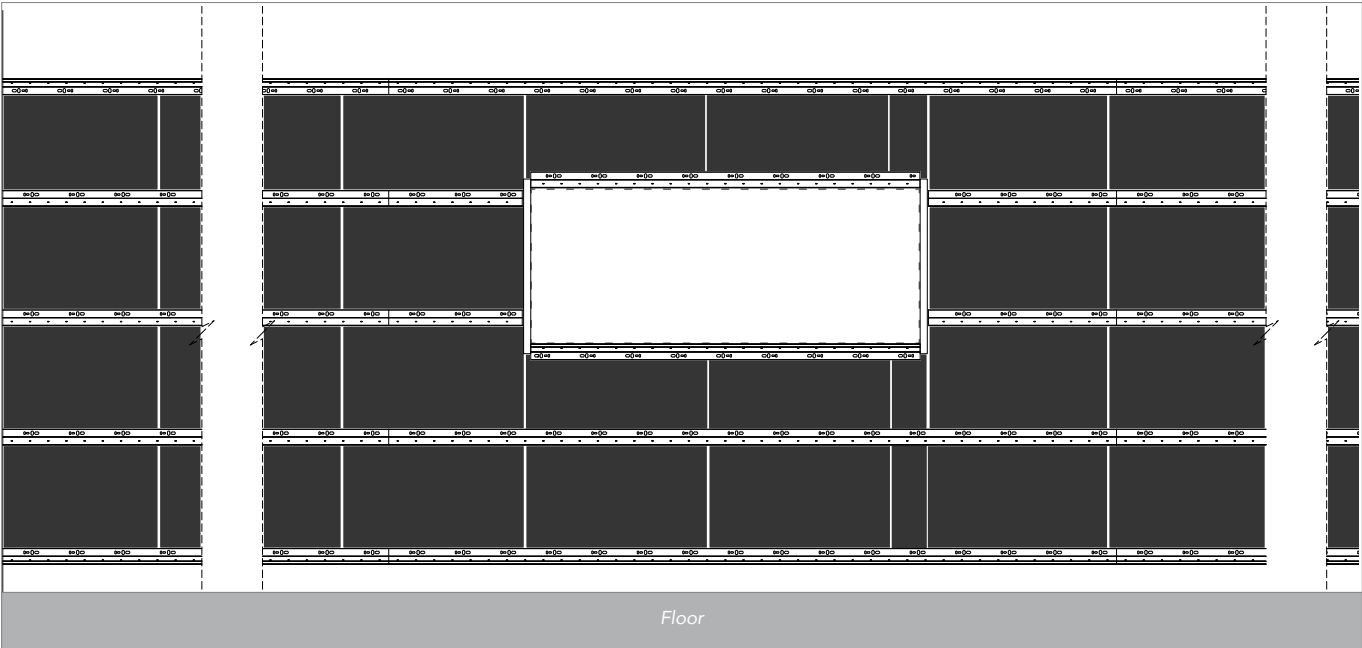

Follow the cut of the panels from top to bottom, with one straight cut line as result.

16 Attach the first clips.

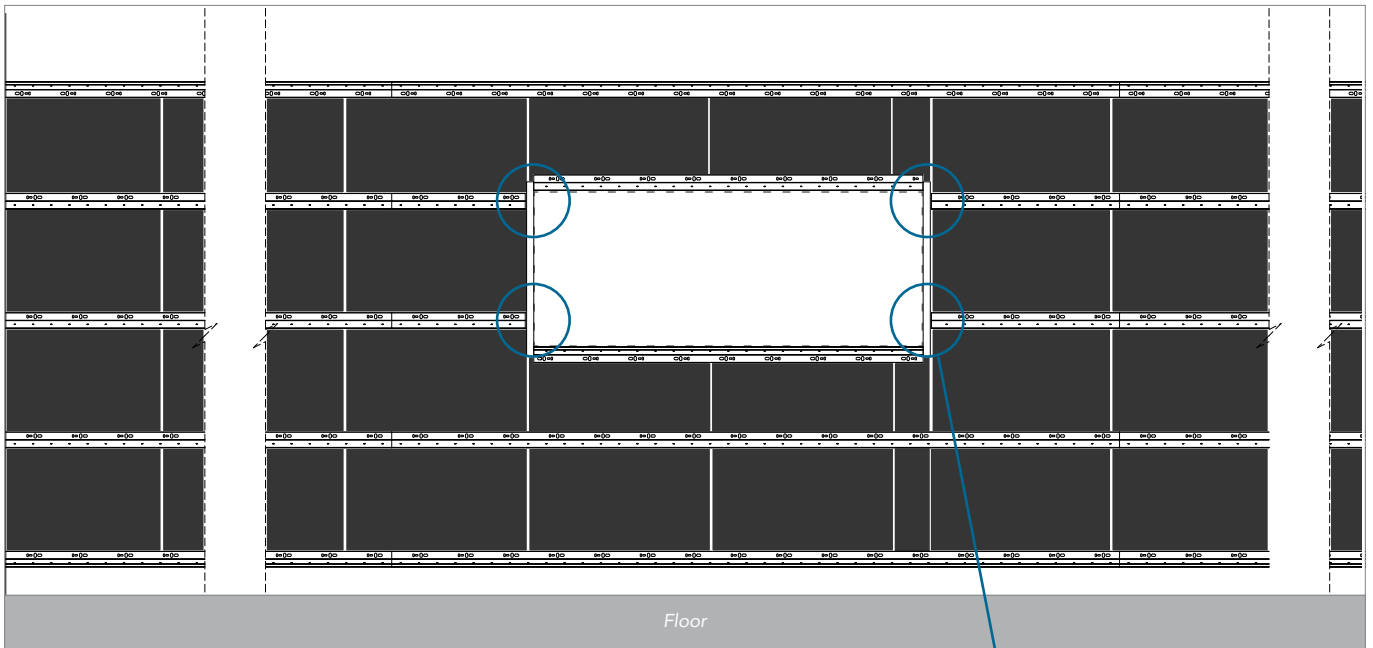

Place the first Mounting Clips that sit closest to the End Profiles.
Use the Guiding Ruler according to the choice of Lamella.

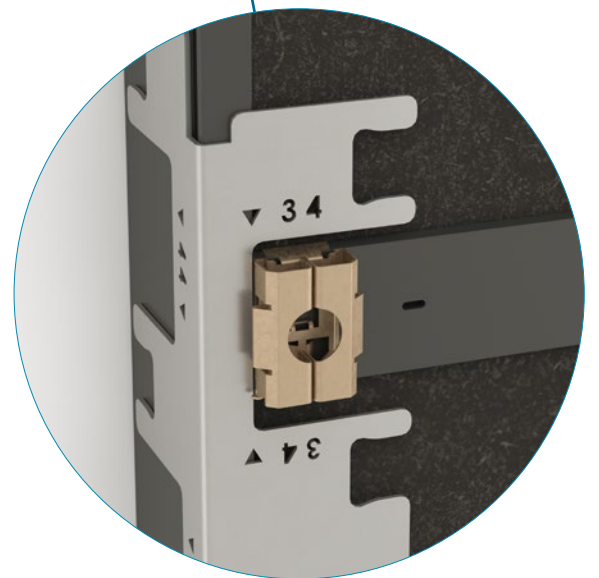

17a Align and mount clips (option A).

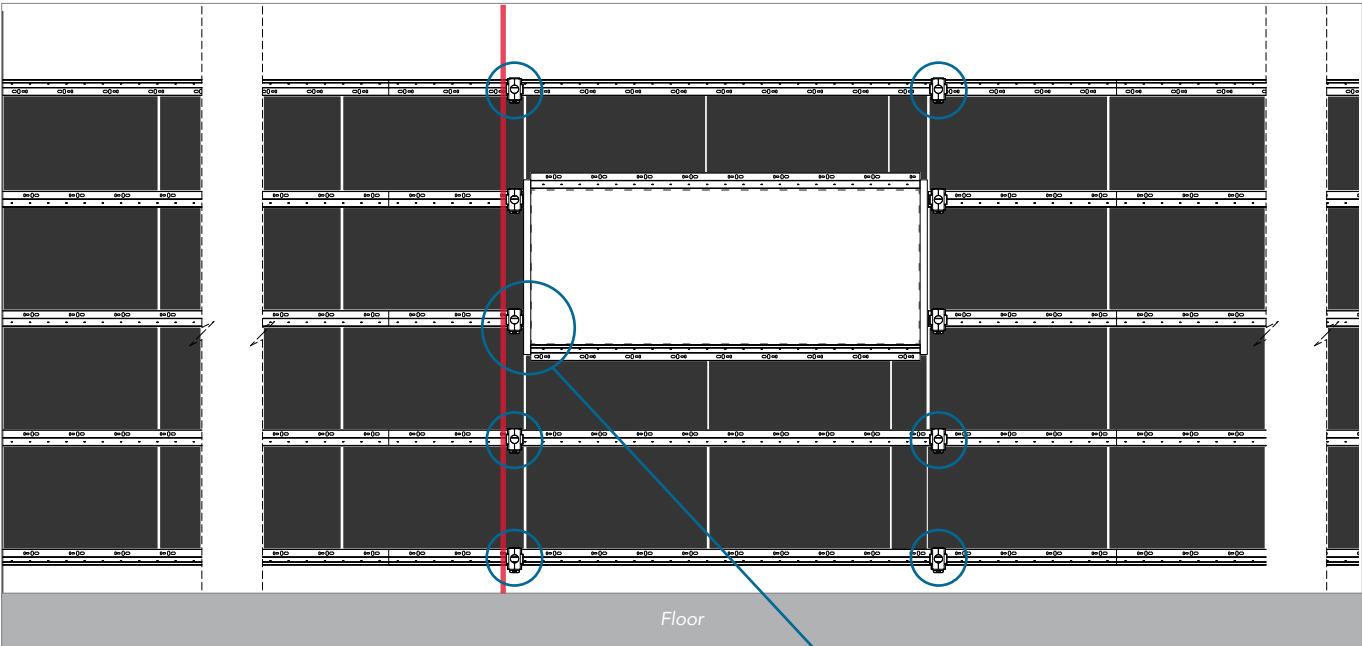

Place a long spirit level or other tool (red line) alongside the clips mounted in step 16. Then align and mount the clips in the blue circles.

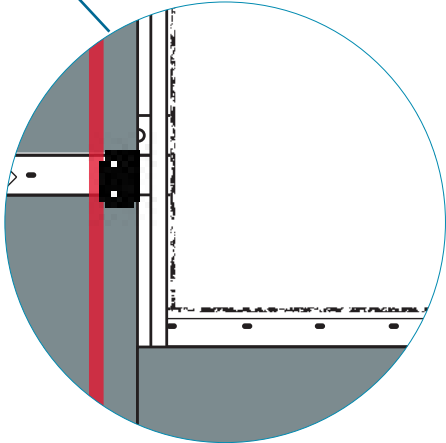

17b Align and mount clips (option B).

— Laser

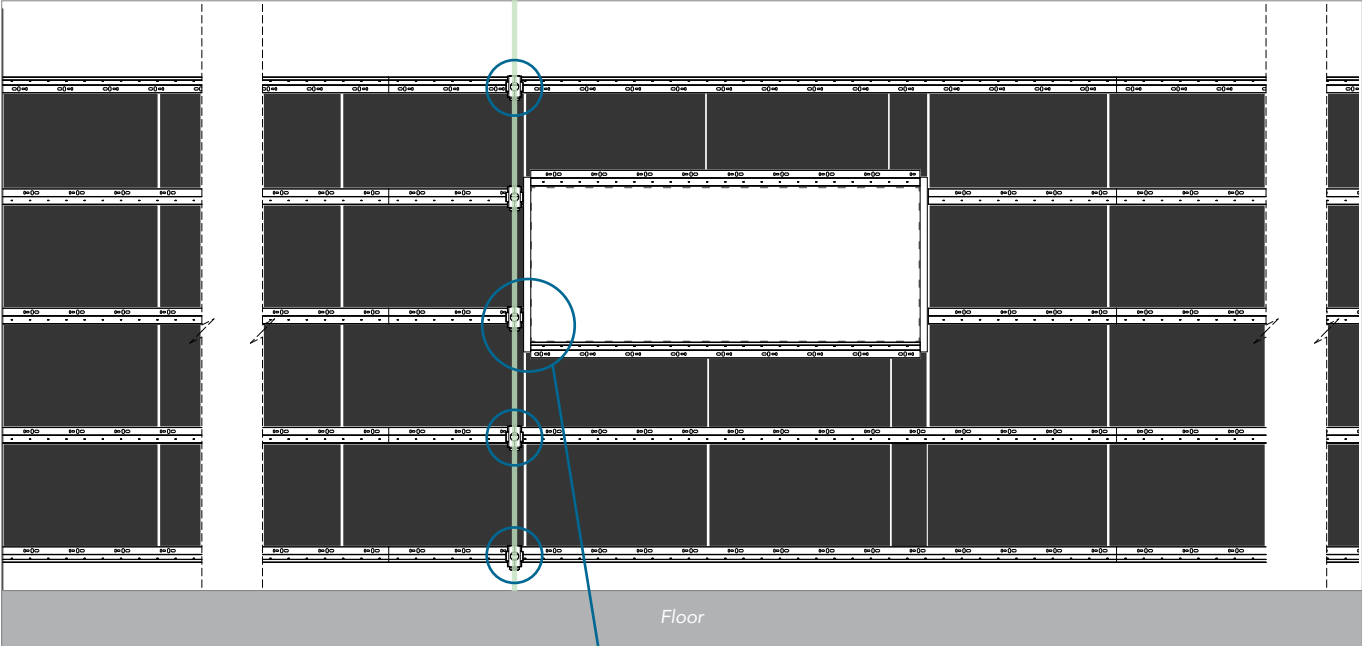

Attach all the Mounting Clips centered on the laser.
Repeat on the other side of the frame.

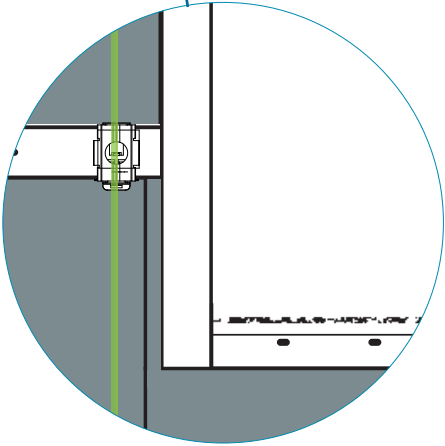

TIP



Alternative to laser: If you mount the first two clips on each side of the frame using the guide ruler, you can use a long spirit level or other straight element to position the next clips in a vertical line above and below by putting the element towards the sides of the mounted clips.

18 Attach following Mounting Clips (1).

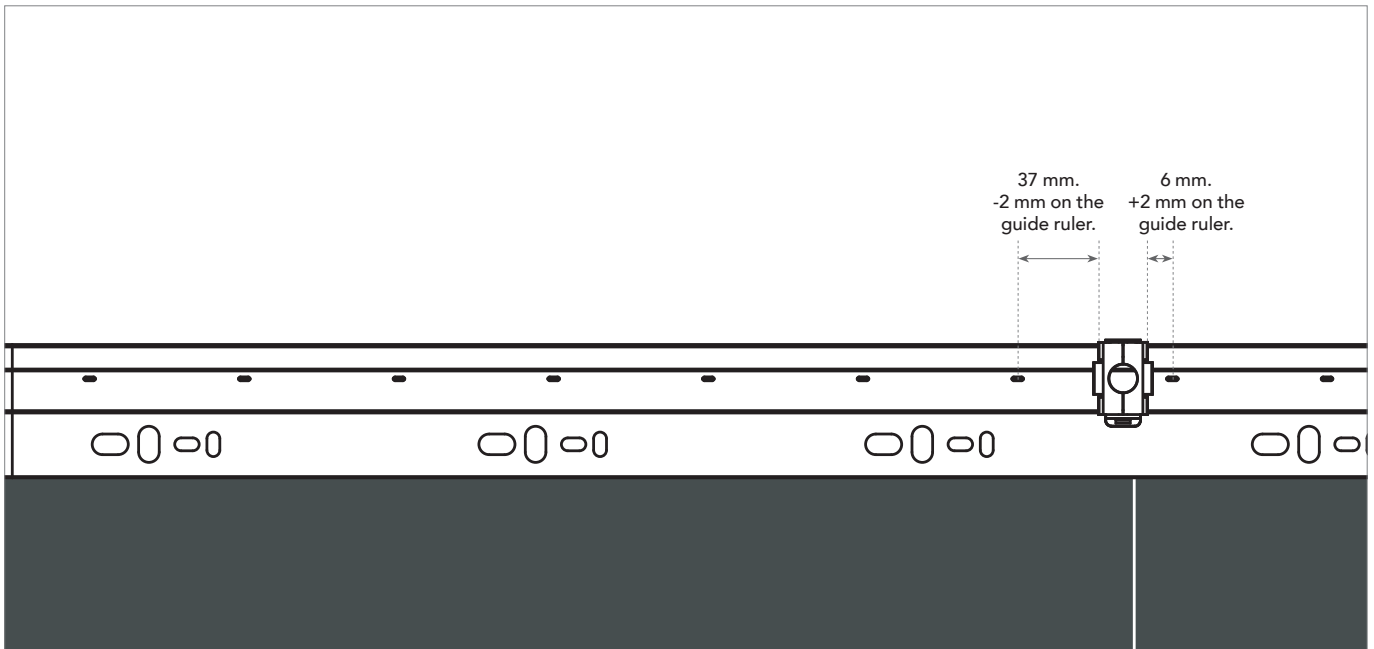

Measure the distance from the side of the Mounting Clip to the center of the nearest alignment hole in the profile. The distance determines what spacing to be used on the Guiding Ruler when placing the next Mounting Clips:

- If distance is between 21,1mm and 51,5 mm, use the -2 mm side of the Guiding Ruler.
- In all other cases, use the +2 mm side of the Guiding Ruler.

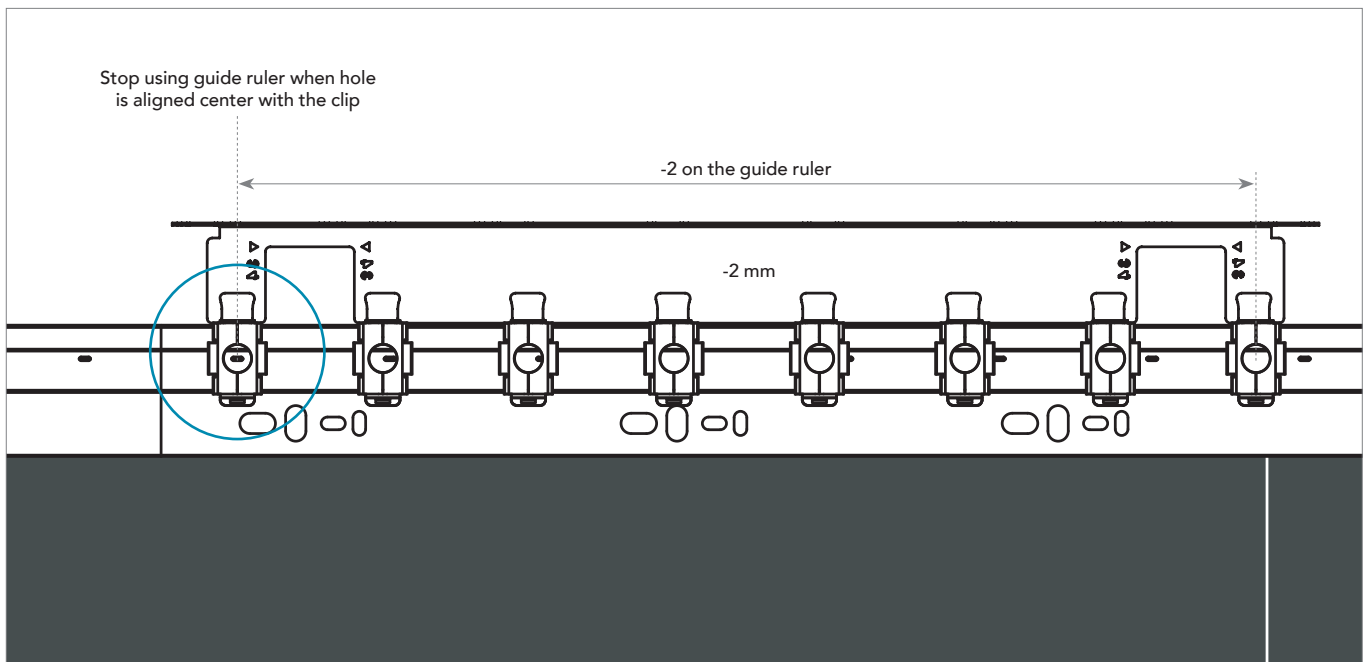

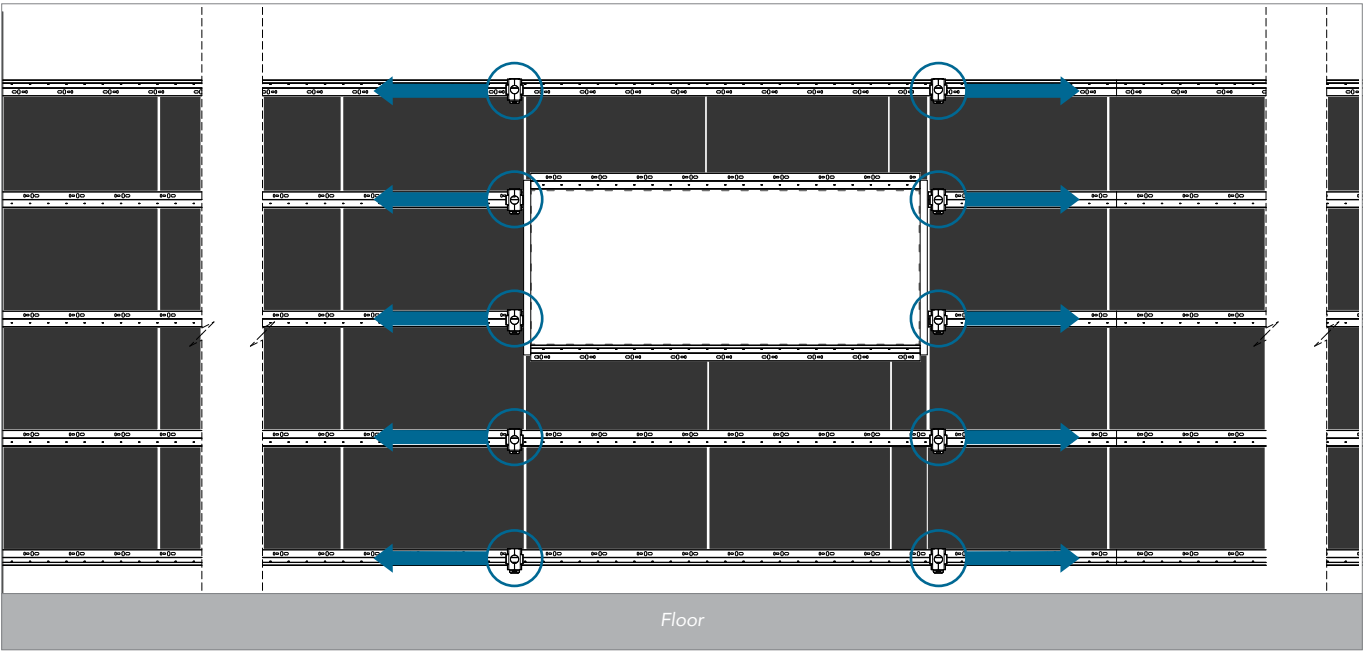

Example: 15 mm is not in between 21,1 mm and 51,5 mm = use +2 mm side of the Guiding Ruler.

19 Attach following Mounting Clips (2).



Mount all clips using the Guiding Ruler, except the clips on the Horizontal Profiles above and below the frame. Start on the marks and work in the direction of the arrows.

RECOMMENDATIONS 
If +2 mm is used in one direction, -2 mm should be used in the opposing direction and vice versa.

TIP 
Stop using the Guiding Ruler when the clip is aligned with an alignment hole.

20 Attach Mounting Clips on remaining Top/Bottom and Middle profiles.

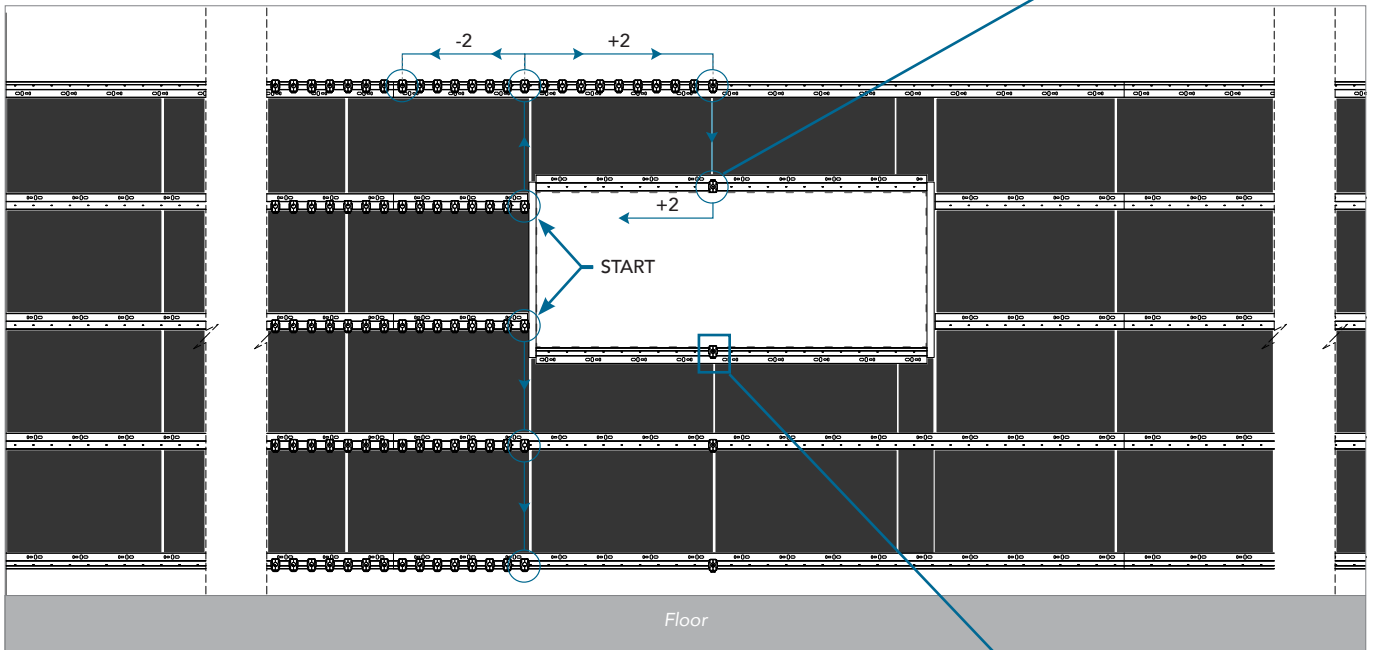

- a) Locate the first clip that uses the alignment hole above and below the frame profiles.
- b) Attach the first clip in the horizontal frame profiles on the same vertical line on the frame profiles.
- c) Put the Guiding Ruler on the attached clip and work your way back towards the vertical frame profiles using the same distance as above/below (+2 / -2 mm). Repeat on the other side.

RECOMMENDATIONS 

When placing clips in the horizontal frame profiles, make sure the clips are turned with the snap wing turning away from the frame.

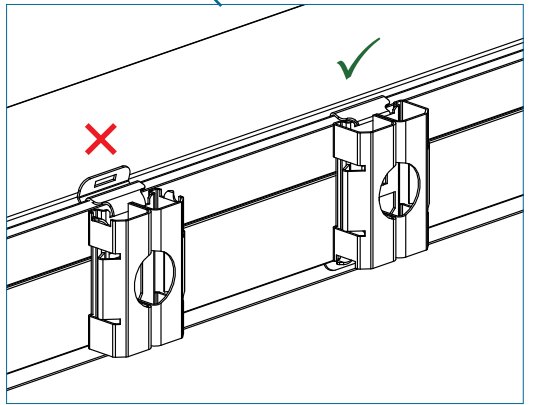

21 Attach remaining Mounting clips on horizontal frame profiles.

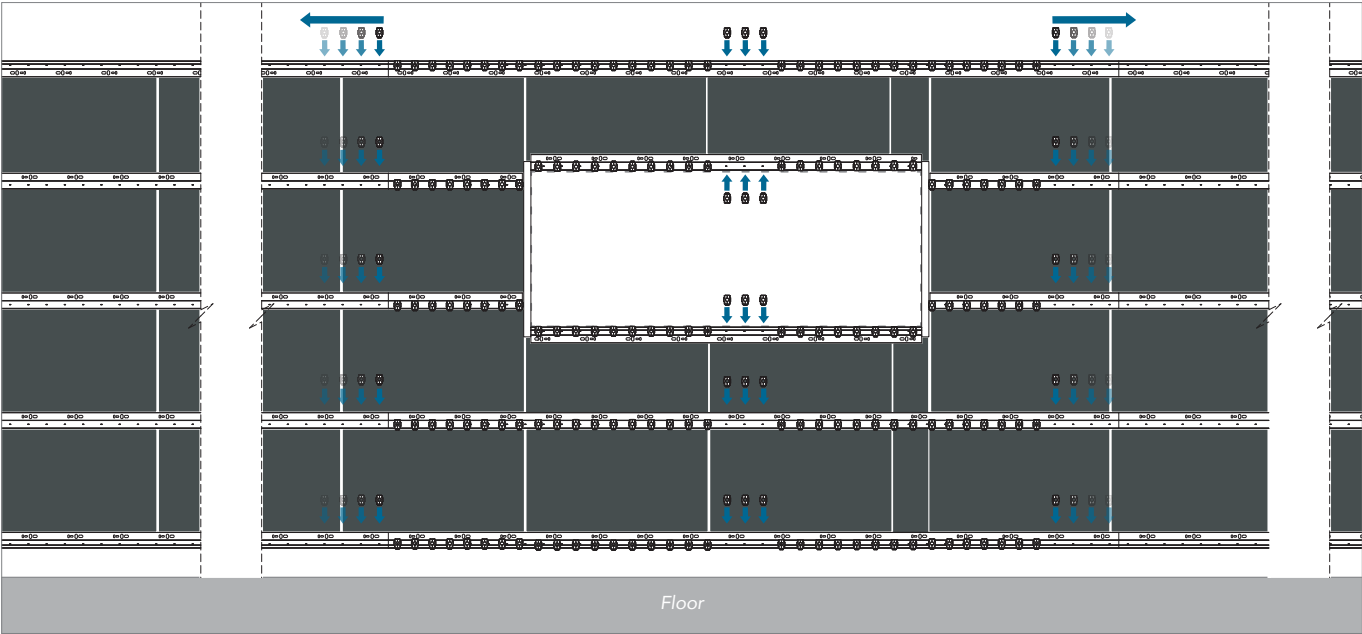

Place the remaining Mounting Clips using the alignment holes in the horizontal frame profiles.

22 Mount the Rockfon Lamella Slats.

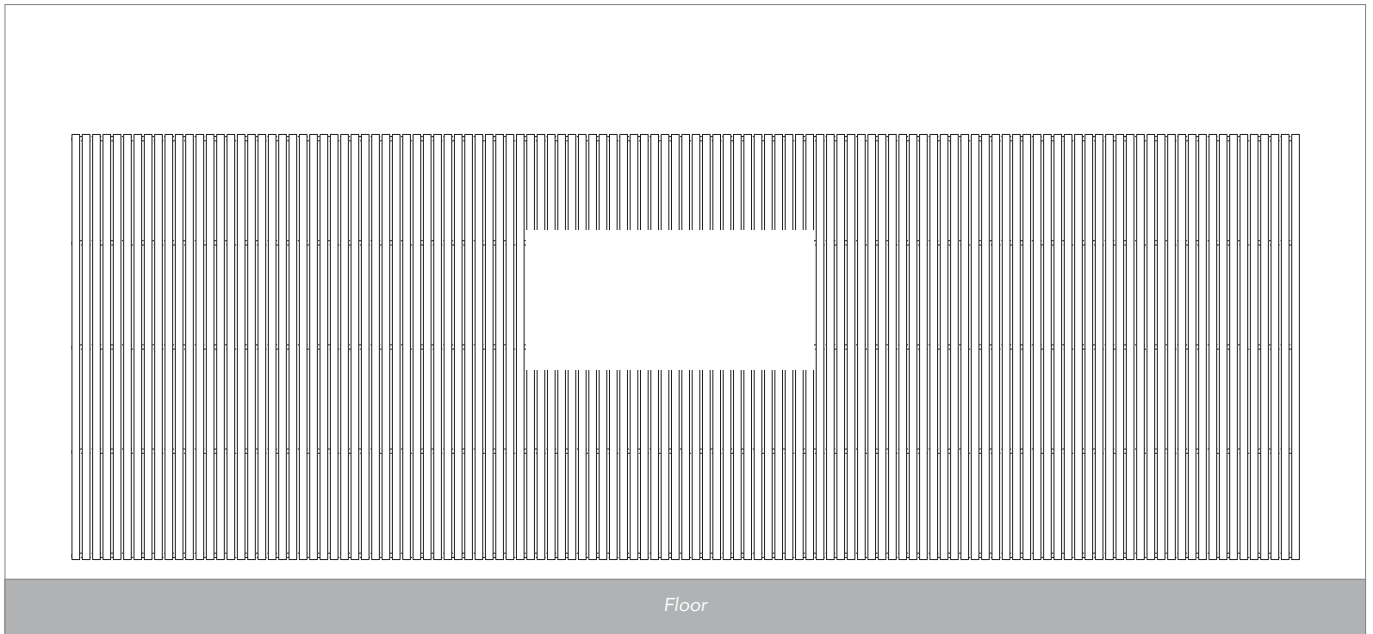

Cut and mount the Lamella Slats by clicking them onto the Mounting Clips.

RECOMMENDATIONS



Place the cut side of the Lamella Slat to the floor or to the ceiling.

Sounds Beautiful

